

DATA Flow report during tests

Xavier Grave

Institut de Physique Nucléaire d'Orsay/CNRS

1st April 2009

Summary

Week 51 tests

Preparation
Tests Setup
Results

Week 8 Tests

Preparation
Tests Setup
Results

Week 12 Tests

Preparation
Tests Setup
Results

Week 51 tests

Preparation
Tests Setup
Results

Week 8 Tests

Preparation
Tests Setup
Results

Week 12 Tests

Preparation
Tests Setup
Results

Summary

Week 51 tests

Preparation
Tests Setup
Results

Week 8 Tests

Preparation
Tests Setup
Results

Week 12 Tests

Preparation
Tests Setup
Results

Xavier Grave

Summary

Week 51 tests

Preparation
Tests Setup
Results

Week 8 Tests

Preparation
Tests Setup
Results

Week 12 Tests

Preparation
Tests Setup
Results

▶ Event Number Based

Xavier Grave

- ▶ Event Number Based
- ▶ Time Stamp based

Summary

Week 51 tests

Preparation
Tests Setup
Results

Week 8 Tests

Preparation
Tests Setup
Results

Week 12 Tests

Preparation
Tests Setup
Results

Xavier Grave

- ▶ Event Number Based
- ▶ Time Stamp based
- ▶ Tests with ADF

Summary

Week 51 tests

Preparation
Tests Setup
Results

Week 8 Tests

Preparation
Tests Setup
Results

Week 12 Tests

Preparation
Tests Setup
Results

Event builder algorithm scheme

Xavier Grave

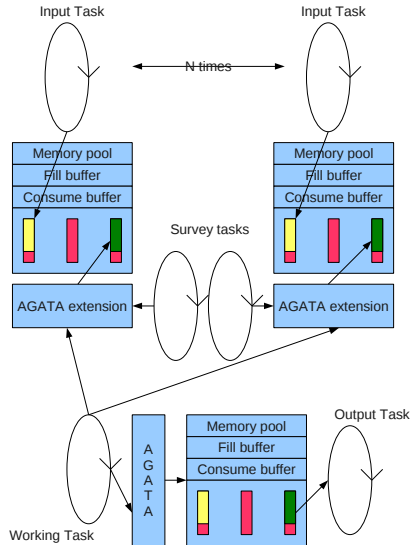

Summary

Week 51 tests

Preparation
Tests Setup
Results

Week 8 Tests

Preparation
Tests Setup
Results

Week 12 Tests

Preparation
Tests Setup
Results

Xavier Grave

Summary

Week 51 tests

Preparation

Tests Setup

Results

Week 8 Tests

Preparation

Tests Setup

Results

Week 12 Tests

Preparation

Tests Setup

Results

- ▶ Producer : File readout

Xavier Grave

Summary

Week 51 tests

Preparation

Tests Setup

Results

Week 8 Tests

Preparation

Tests Setup

Results

Week 12 Tests

Preparation

Tests Setup

Results

- ▶ Producer : File readout
- ▶ Filters

Xavier Grave

- ▶ Producer : File readout
- ▶ Filters
 - ▶ PreProcessing with and without ROOT

Summary

Week 51 tests

Preparation
Tests Setup
Results

Week 8 Tests

Preparation
Tests Setup
Results

Week 12 Tests

Preparation
Tests Setup
Results

- ▶ Producer : File readout
- ▶ Filters
 - ▶ PreProcessing with and without ROOT
 - ▶ PSA

Summary

Week 51 tests

Preparation
Tests Setup
Results

Week 8 Tests

Preparation
Tests Setup
Results

Week 12 Tests

Preparation
Tests Setup
Results

Xavier Grave

Summary

Week 51 tests

Preparation
Tests Setup
Results

Week 8 Tests

Preparation
Tests Setup
Results

Week 12 Tests

Preparation
Tests Setup
Results

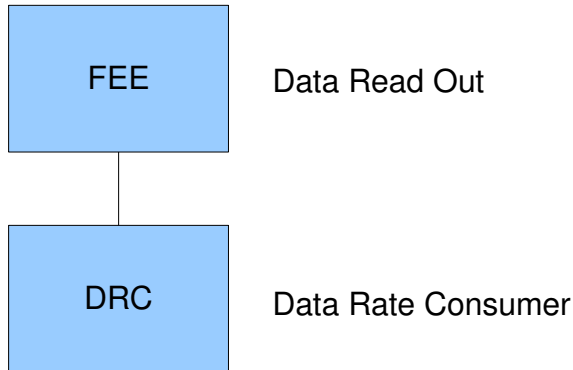

Xavier Grave

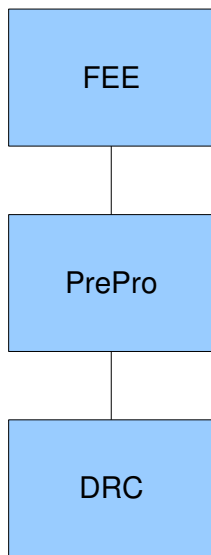

Data Calibration

Summary

Week 51 tests

Preparation
Tests Setup
Results

Week 8 Tests

Preparation
Tests Setup
Results

Week 12 Tests

Preparation
Tests Setup
Results

Xavier Grave

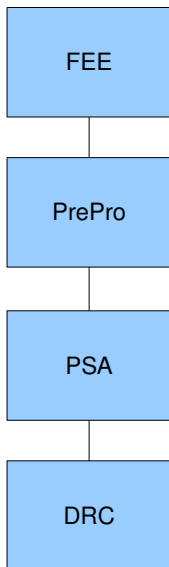

Pulse Shape Analysis

Summary

Week 51 tests

Preparation
Tests Setup
Results

Week 8 Tests

Preparation
Tests Setup
Results

Week 12 Tests

Preparation
Tests Setup
Results

Xavier Grave

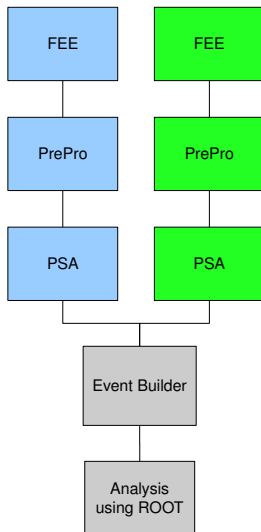

Summary

Week 51 tests

Preparation
Tests Setup
Results

Week 8 Tests

Preparation
Tests Setup
Results

Week 12 Tests

Preparation
Tests Setup
Results

Xavier Grave

Summary

Week 51 tests

Preparation

Tests Setup

Results

Week 8 Tests

Preparation

Tests Setup

Results

Week 12 Tests

Preparation

Tests Setup

Results

Validation of :

- ▶ Main libraries interface

Xavier Grave

Validation of :

- ▶ Main libraries interface
- ▶ ADF library

Summary

Week 51 tests

Preparation
Tests Setup
Results

Week 8 Tests

Preparation
Tests Setup
Results

Week 12 Tests

Preparation
Tests Setup
Results

Validation of :

- ▶ Main libraries interface
- ▶ ADF library
- ▶ Event builder time stamp based

Summary

Week 51 tests

Preparation
Tests Setup
Results

Week 8 Tests

Preparation
Tests Setup
Results

Week 12 Tests

Preparation
Tests Setup
Results

Validation of :

- ▶ Main libraries interface
- ▶ ADF library
- ▶ Event builder time stamp based

Most of the work \Rightarrow libraries integration

Summary

Week 51 tests

Preparation
Tests Setup
Results

Week 8 Tests

Preparation
Tests Setup
Results

Week 12 Tests

Preparation
Tests Setup
Results

Validation of :

- ▶ Main libraries interface
- ▶ ADF library
- ▶ Event builder time stamp based

Most of the work \Rightarrow libraries integration
Following weeks work

Summary

Week 51 tests

Preparation
Tests Setup
Results

Week 8 Tests

Preparation
Tests Setup
Results

Week 12 Tests

Preparation
Tests Setup
Results

Validation of :

- ▶ Main libraries interface
- ▶ ADF library
- ▶ Event builder time stamp based

Most of the work \Rightarrow libraries integration

Following weeks work

- ▶ Using GRU instead of ROOT

Summary

Week 51 tests

Preparation
Tests Setup
Results

Week 8 Tests

Preparation
Tests Setup
Results

Week 12 Tests

Preparation
Tests Setup
Results

Validation of :

- ▶ Main libraries interface
- ▶ ADF library
- ▶ Event builder time stamp based

Most of the work \Rightarrow libraries integration

Following weeks work

- ▶ Using GRU instead of ROOT
- ▶ Integrate Tracking in Data Flow

Summary

Week 51 tests

Preparation
Tests Setup
Results

Week 8 Tests

Preparation
Tests Setup
Results

Week 12 Tests

Preparation
Tests Setup
Results

Xavier Grave

- ▶ Adaptation of carrier linux driver to Narval Nodes Operating System (Debian GNU/Linux 64 bits)

Summary

Week 51 tests

Preparation
Tests Setup
Results

Week 8 Tests

Preparation
Tests Setup
Results

Week 12 Tests

Preparation
Tests Setup
Results

- ▶ Adaptation of carrier linux driver to Narval Nodes Operating System (Debian GNU/Linux 64 bits)
- ▶ Tests different topologies with data taken directly from crystal

Summary

Week 51 tests

Preparation
Tests Setup
Results

Week 8 Tests

Preparation
Tests Setup
Results

Week 12 Tests

Preparation
Tests Setup
Results

Xavier Grave

- ▶ Adaptation of carrier linux driver to Narval Nodes Operating System (Debian GNU/Linux 64 bits)
- ▶ Tests different topologies with data taken directly from crystal
- ▶ Two new actors to distribute and collect data to ease parallel work

Summary

Week 51 tests

Preparation
Tests Setup
Results

Week 8 Tests

Preparation
Tests Setup
Results

Week 12 Tests

Preparation
Tests Setup
Results

Xavier Grave

- ▶ Producer : File readout

Summary

Week 51 tests

Preparation
Tests Setup
Results

Week 8 Tests

Preparation
Tests Setup
Results

Week 12 Tests

Preparation
Tests Setup
Results

Xavier Grave

- ▶ Producer : File readout
- ▶ Filters

Summary

Week 51 tests

Preparation
Tests Setup
Results

Week 8 Tests

Preparation
Tests Setup
Results

Week 12 Tests

Preparation
Tests Setup
Results

Xavier Grave

- ▶ Producer : File readout
- ▶ Filters
 - ▶ PreProcessing

Summary

Week 51 tests

Preparation
Tests Setup
Results

Week 8 Tests

Preparation
Tests Setup
Results

Week 12 Tests

Preparation
Tests Setup
Results

- ▶ Producer : File readout
- ▶ Filters
 - ▶ PreProcessing
 - ▶ PSA

Summary

Week 51 tests

Preparation
Tests Setup
Results

Week 8 Tests

Preparation
Tests Setup
Results

Week 12 Tests

Preparation
Tests Setup
Results

- ▶ Producer : File readout
- ▶ Filters
 - ▶ PreProcessing
 - ▶ PSA
 - ▶ Tracking

Summary

Week 51 tests

Preparation
Tests Setup
Results

Week 8 Tests

Preparation
Tests Setup
Results

Week 12 Tests

Preparation
Tests Setup
Results

- ▶ Producer : File readout
- ▶ Filters
 - ▶ PreProcessing
 - ▶ PSA
 - ▶ Tracking

ROOT histogramming replaced by GRU servers and vigruc client

Summary

Week 51 tests

Preparation
Tests Setup
Results

Week 8 Tests

Preparation
Tests Setup
Results

Week 12 Tests

Preparation
Tests Setup
Results

Xavier Grave

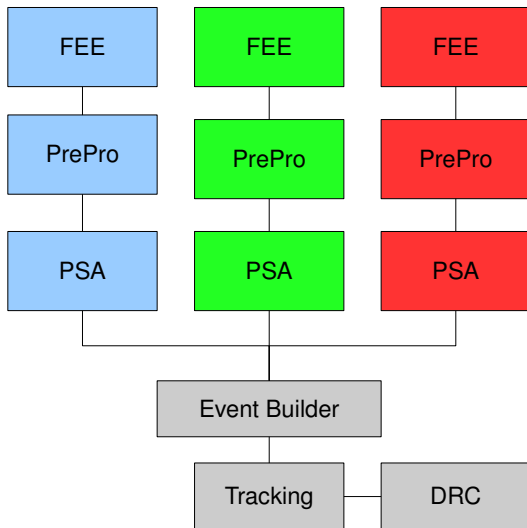

Summary

Week 51 tests

Preparation
Tests Setup
Results

Week 8 Tests

Preparation
Tests Setup
Results

Week 12 Tests

Preparation
Tests Setup
Results

Xavier Grave

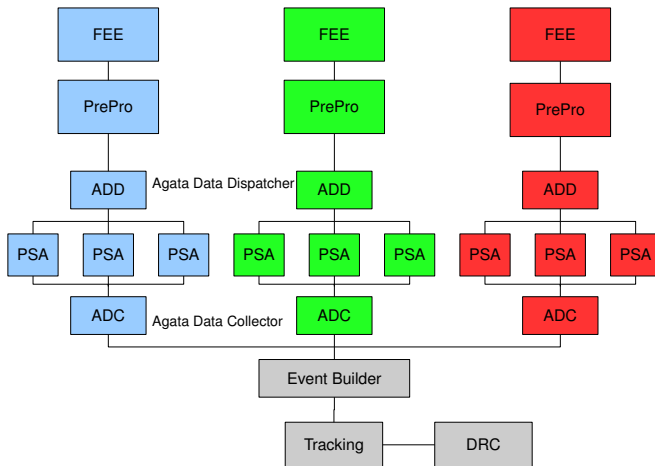

Summary

Week 51 tests

Preparation
Tests Setup
Results

Week 8 Tests

Preparation
Tests Setup
Results

Week 12 Tests

Preparation
Tests Setup
Results

Xavier Grave

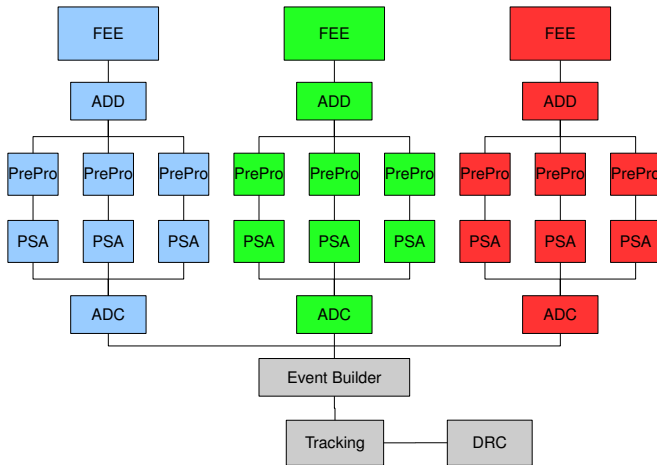

Summary

Week 51 tests

Preparation
Tests Setup
Results

Week 8 Tests

Preparation
Tests Setup
Results

Week 12 Tests

Preparation
Tests Setup
Results

Summary

Week 51 tests

Preparation
Tests Setup
Results

Week 8 Tests

Preparation
Tests Setup
Results

Week 12 Tests

Preparation
Tests Setup
Results

Validation of :

- ▶ Full Chain from Crystals to Tracking, including
 - ▶ ADF interfacing
 - ▶ GRU histogramming

Summary

Week 51 tests

Preparation
Tests Setup
Results

Week 8 Tests

Preparation
Tests Setup
Results

Week 12 Tests

Preparation
Tests Setup
Results

Validation of :

- ▶ Full Chain from Crystals to Tracking, including
 - ▶ ADF interfacing
 - ▶ GRU histogramming
- ▶ Complex topologies, except for the more complex one

Xavier Grave

- ▶ Topologies files
 - ▶ PCIXpress Data readout
 - ▶ Raw Files readout

Summary

Week 51 tests

Preparation
Tests Setup
Results

Week 8 Tests

Preparation
Tests Setup
Results

Week 12 Tests

Preparation
Tests Setup
Results

- ▶ Topologies files
 - ▶ PCIXpress Data readout
 - ▶ Raw Files readout
- ▶ Narval script files
 - ▶ Run Control compatible ones
 - ▶ Narval Shell compatible ones

Summary

Week 51 tests

Preparation
Tests Setup
Results

Week 8 Tests

Preparation
Tests Setup
Results

Week 12 Tests

Preparation
Tests Setup
Results

- ▶ Topologies files
 - ▶ PCIXpress Data readout
 - ▶ Raw Files readout
- ▶ Narval script files
 - ▶ Run Control compatible ones
 - ▶ Narval Shell compatible ones
- ▶ Wiki documentation
 - ▶ Topologies description
 - ▶ Cracow and Run Control How To
 - ▶ Troubleshooting
 - ▶ Wiki clone <http://csngwinfo.in2p3.fr/mediawiki>
 - ▶ Original wiki <http://tursiops/> from DAQ LAN

Summary

Week 51 tests

Preparation
Tests Setup
Results

Week 8 Tests

Preparation
Tests Setup
Results

Week 12 Tests

Preparation
Tests Setup
Results

Xavier Grave

Summary

Week 51 tests

Preparation
Tests Setup
Results

Week 8 Tests

Preparation
Tests Setup
Results

Week 12 Tests

Preparation
Tests Setup
Results

- ▶ Producer : File readout and PCIXpress readout

Xavier Grave

- ▶ Producer : File readout and PCIXpress readout
- ▶ Filters

Summary

Week 51 tests

Preparation
Tests Setup
Results

Week 8 Tests

Preparation
Tests Setup
Results

Week 12 Tests

Preparation
Tests Setup
Results

- ▶ Producer : File readout and PCIXpress readout
- ▶ Filters
 - ▶ PreProcessing

Summary

Week 51 tests

Preparation
Tests Setup
Results

Week 8 Tests

Preparation
Tests Setup
Results

Week 12 Tests

Preparation
Tests Setup
Results

- ▶ Producer : File readout and PCIXpress readout
- ▶ Filters
 - ▶ PreProcessing
 - ▶ PSA

Summary

Week 51 tests

Preparation
Tests Setup
Results

Week 8 Tests

Preparation
Tests Setup
Results

Week 12 Tests

Preparation
Tests Setup
Results

- ▶ Producer : File readout and PCIXpress readout
- ▶ Filters
 - ▶ PreProcessing
 - ▶ PSA
 - ▶ Tracking

Summary

Week 51 tests

Preparation
Tests Setup
Results

Week 8 Tests

Preparation
Tests Setup
Results

Week 12 Tests

Preparation
Tests Setup
Results

- ▶ Producer : File readout and PCIXpress readout
- ▶ Filters
 - ▶ PreProcessing
 - ▶ PSA
 - ▶ Tracking
- ▶ Consumer

Summary

Week 51 tests

Preparation
Tests Setup
Results

Week 8 Tests

Preparation
Tests Setup
Results

Week 12 Tests

Preparation
Tests Setup
Results

- ▶ Producer : File readout and PCIXpress readout
- ▶ Filters
 - ▶ PreProcessing
 - ▶ PSA
 - ▶ Tracking
- ▶ Consumer
 - ▶ Storage, available but not used

Summary

Week 51 tests

Preparation
Tests Setup
Results

Week 8 Tests

Preparation
Tests Setup
Results

Week 12 Tests

Preparation
Tests Setup
Results

Xavier Grave

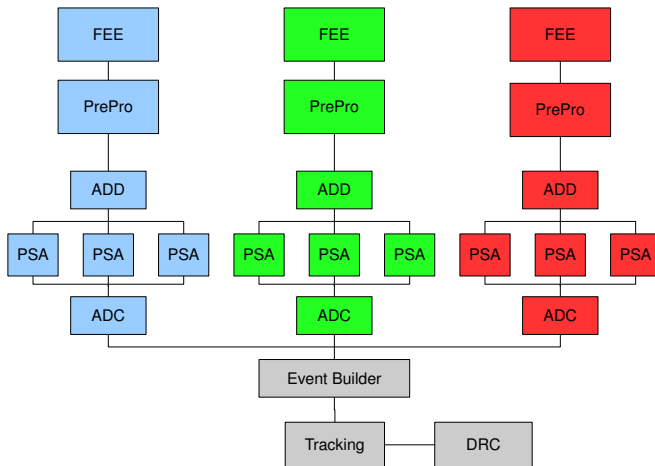

Summary

Week 51 tests

Preparation
Tests Setup
Results

Week 8 Tests

Preparation
Tests Setup
Results

Week 12 Tests

Preparation
Tests Setup
Results

Xavier Grave

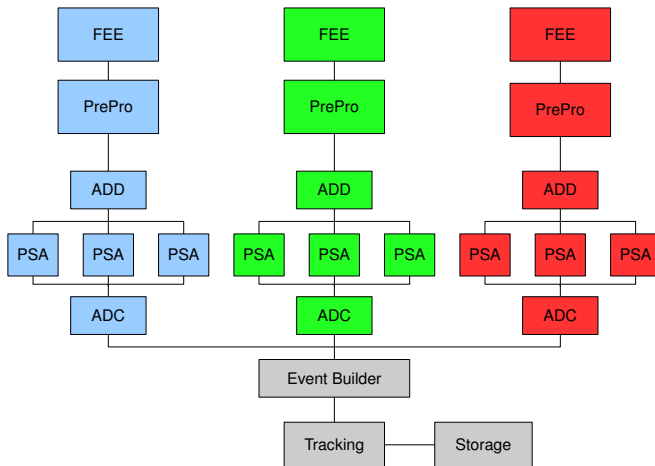

Summary

Week 51 tests

Preparation
Tests Setup
Results

Week 8 Tests

Preparation
Tests Setup
Results

Week 12 Tests

Preparation
Tests Setup
Results

Xavier Grave

Validation of :

- ▶ Full Data Flow

Summary

Week 51 tests

Preparation
Tests Setup
Results

Week 8 Tests

Preparation
Tests Setup
Results

Week 12 Tests

Preparation
Tests Setup
Results

Validation of :

- ▶ Full Data Flow
 - ▶ PCIXpress readout in data flow

Summary

Week 51 tests

Preparation
Tests Setup
Results

Week 8 Tests

Preparation
Tests Setup
Results

Week 12 Tests

Preparation
Tests Setup
Results

Validation of :

- ▶ Full Data Flow
 - ▶ PCIXpress readout in data flow
 - ▶ All algorithms integration (readout, preprocessing, psa, tracking)

Summary

Week 51 tests

Preparation
Tests Setup
Results

Week 8 Tests

Preparation
Tests Setup
Results

Week 12 Tests

Preparation
Tests Setup
Results

Validation of :

- ▶ Full Data Flow
 - ▶ PCIXpress readout in data flow
 - ▶ All algorithms integration (readout, preprocessing, psa, tracking)
 - ▶ Run Control

Summary

Week 51 tests

Preparation
Tests Setup
Results

Week 8 Tests

Preparation
Tests Setup
Results

Week 12 Tests

Preparation
Tests Setup
Results

Validation of :

- ▶ Full Data Flow
 - ▶ PCIXpress readout in data flow
 - ▶ All algorithms integration (readout, preprocessing, psa, tracking)
 - ▶ Run Control
 - ▶ Cracow GUI

Summary

Week 51 tests

Preparation
Tests Setup
Results

Week 8 Tests

Preparation
Tests Setup
Results

Week 12 Tests

Preparation
Tests Setup
Results

Validation of :

- ▶ Full Data Flow
 - ▶ PCIXpress readout in data flow
 - ▶ All algorithms integration (readout, preprocessing, psa, tracking)
 - ▶ Run Control
 - ▶ Cracow GUI

Future work :

Summary

Week 51 tests

Preparation
Tests Setup
Results

Week 8 Tests

Preparation
Tests Setup
Results

Week 12 Tests

Preparation
Tests Setup
Results

Validation of :

- ▶ Full Data Flow
 - ▶ PCIXpress readout in data flow
 - ▶ All algorithms integration (readout, preprocessing, psa, tracking)
 - ▶ Run Control
 - ▶ Cracow GUI

Future work :

- ▶ Include ancillary detector

Summary

Week 51 tests

Preparation
Tests Setup
Results

Week 8 Tests

Preparation
Tests Setup
Results

Week 12 Tests

Preparation
Tests Setup
Results

Validation of :

- ▶ Full Data Flow
 - ▶ PCIXpress readout in data flow
 - ▶ All algorithms integration (readout, preprocessing, psa, tracking)
 - ▶ Run Control
 - ▶ Cracow GUI

Future work :

- ▶ Include ancillary detector
- ▶ Optimize various codes (Event Builder, ADF library, PSA...)

Summary

Week 51 tests

Preparation
Tests Setup
Results

Week 8 Tests

Preparation
Tests Setup
Results

Week 12 Tests

Preparation
Tests Setup
Results